

### RoHS HF 437 Series – 1206 Fast-Acting Fuse





#### Description

This 100% Lead-free, RoHS compliant and Halogen-free fuse series has been designed specifically to provide over current protection to circuits that see high working ambient temperatures (up to 150°C).

The general design ensures excellent temperature stability and performance reliability.

In addition to this, the high I<sup>2</sup>t values typical of the Littelfuse Ceramic Fuse family ensure high inrush current withstand capability.

#### Agency Approvals

AGENCY	AGENCY FILE NUMBER	AMPERE RANGE
	E10480	0.250A ~ 8A
	LR29862	0.250A ~ 8A

#### Electrical Characteristics for Series

% of Ampere Rating	Ampere Rating	Opening Time at 25°C
100%	250mA - 8A	4 hours, Minimum
250%	750mA - 8A	5 seconds, Maximum
350%	250mA - 500mA	5 seconds, Maximum
350%	750mA - 8A	1 second, Maximum



#### Features

- Operating Temperature from -55°C to +150°C
- Suitable for both leaded and lead-free reflow / wave soldering
- 100% Lead-free and RoHS compliant

#### Applications

- Automotive Electronics
- Printers
- LCD Displays
- Scanners
- Servers
- Data Modems

#### Electrical Specifications by Item

Ampere Rating (A)	Amp Code	Max. Voltage Rating (V)	Interrupting Rating	Nominal Resistance (Ohms) <sup>2</sup>	Nominal Melting I <sup>2</sup> t (A <sup>2</sup> Sec.) <sup>3</sup>	Nominal Voltage Drop At Rated Current (V) <sup>4</sup>	Nominal Power Dissipation At Rated Current (W)	Agency Approvals	
									
250mA	.250	125	50 A @ 125 V AC/DC	2.290	0.003	0.78	0.195	x	x
375mA	.375	125		1.330	0.010	0.60	0.225	x	x
500mA	.500	63		0.908	0.018	0.52	0.260	x	x
750mA	.750	63	50 A @ 63 V AC/DC	0.665	0.064	0.45	0.335	x	x
1A	001.	63		0.360	0.100	0.41	0.415	x	x
1.25A	1.25	63		0.318	0.256	0.40	0.496	x	x
1.5A	01.5	63		0.209	0.324	0.39	0.579	x	x
1.75A	1.75	63		0.0703	0.075	0.27	0.474	x	x
2A	002.	63		0.058	0.144	0.17	0.345	x	x
2.5A	02.5	32	50 A @ 32 V AC/35 V DC	0.043	0.225	0.14	0.363	x	x
3A	003.	32		0.033	0.400	0.15	0.462	x	x
3.5A	03.5	32		0.027	0.576	0.16	0.560	x	x
4A	004.	32		0.022	1.024	0.16	0.618	x	x
5A	005.	32		0.016	1.936	0.09	0.484	x	x
7A	007.	32		0.010	4.900	0.11	0.760	x	x
8A	008.	32		0.0084	6.400	0.067	0.539	x	x

#### Notes:

- AC Interrupting Rating tested at rated voltage with unity power factor. DC Interrupting Rating tested at rated voltage with time constant < 0.8 msec.
- Nominal Resistance measured with < 10% rated current.
- Nominal Melting I<sup>2</sup>t measured at 1 msec. opening time.
- Nominal Voltage Drop measured at rated current after temperature has stabilized.

Devices designed to carry rated current for 4 hours minimum. It is recommended that devices be operated continuously at no more than 80% rated current. See "Temperature Derating Curve" for additional derating information.

Devices designed to be mounted with marking code facing up.

### Temperature Derating Curve

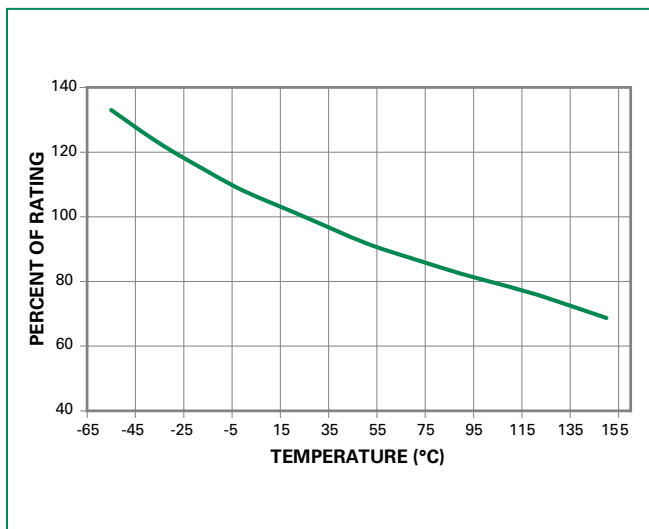

Note:

1. Derating depicted in this curve is in addition to the standard derating of 20% for continuous operation.

Example:

For continuous operation at 75 degrees celsius, the fuse should be derated as follows:

$$I = (0.80)(0.85)I_{RAT} = (0.68)I_{RAT}$$

### Average Time Current Curves

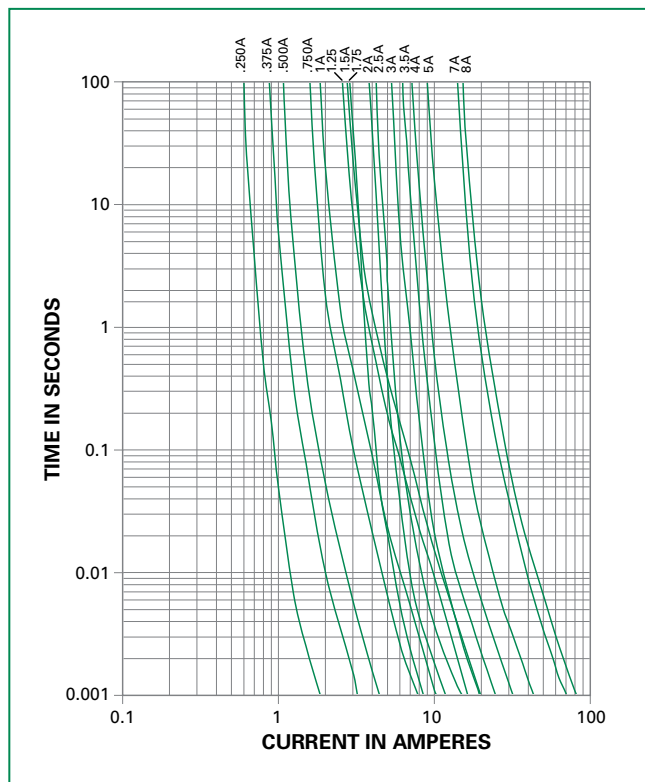

### Soldering Parameters

Reflow Condition	Pb – free assembly	
Pre Heat	- Temperature Min ( $T_{s(min)}$ )	150°C
	- Temperature Max ( $T_{s(max)}$ )	200°C
	- Time (Min to Max) ( $t_s$ )	60 – 180 seconds
Average Ramp-up Rate (Liquidus Temp ( $T_L$ ) to peak)	3°C/second max.	
$T_{s(max)}$ to $T_L$ - Ramp-up Rate	5°C/second max.	
Reflow	- Temperature ( $T_L$ ) (Liquidus)	217°C
	- Temperature ( $t_L$ )	60 – 150 seconds
Peak Temperature ( $T_p$ )	260 <sup>+0/-5</sup> °C	
Time within 5°C of actual peak Temperature ( $t_p$ )	10 – 30 seconds	
Ramp-down Rate	6°C/second max.	
Time 25°C to peak Temperature ( $T_p$ )	8 minutes max.	
Do not exceed	260°C	

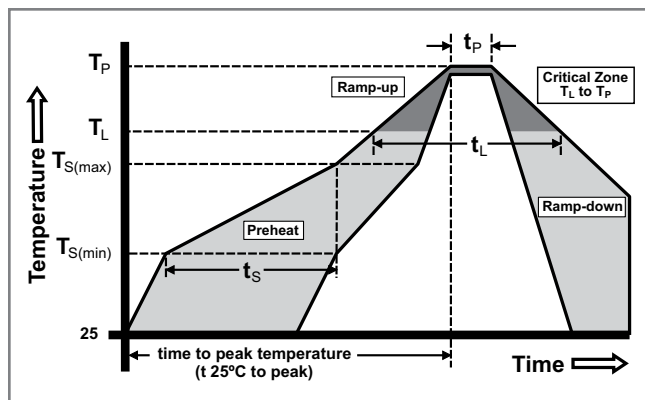

Wave Soldering	260°C, 10 seconds max.
----------------	------------------------

### Product Characteristics

<b>Materials</b>	<b>Body:</b> Advanced Ceramic <b>Terminations:</b> Ag / Ni / Sn (100% Lead-free) <b>Element Cover Coating:</b> Lead-free Glass
<b>Moisture Sensitivity Level</b>	IPC/JEDEC J-STD-020C, Level 1
<b>Solderability</b>	IPC/EIC/JEDEC J-STD-002B, Condition B
<b>Humidity Test</b>	MIL-STD-202, Method 103B, Conditions D
<b>Resistance to Solder Heat</b>	MIL-STD-202, Method 210F, Condition B

<b>Moisture Resistance</b>	MIL-STD-202, Method 106G
<b>Thermal Shock</b>	MIL-STD-202, Method 107G, Condition B
<b>Mechanical Shock</b>	MIL-STD-202, Method 213B, Condition A
<b>Vibration</b>	MIL-STD-202, Method 201A
<b>Vibration, High Frequency</b>	MIL-STD-202, Method 204D, Condition D
<b>Dissolution of Metallization</b>	IPC/EIC/JEDEC J-STD-002B, Condition D
<b>Terminal Strength</b>	IEC 60127-4

### Dimensions

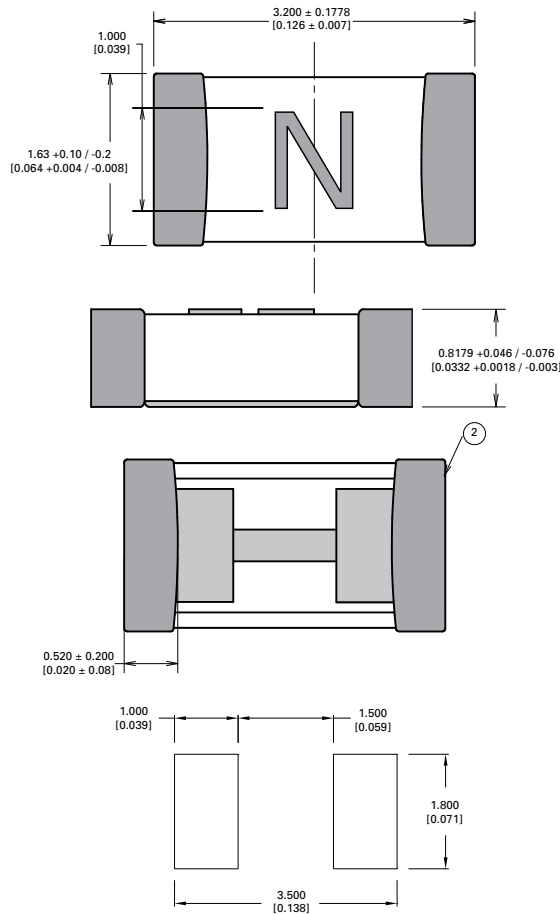

### Part Marking System

Amp Code	Marking Code
.250	<b>D</b>
.375	<b>E</b>
.500	<b>F</b>
.750	<b>G</b>
001.	<b>H</b>
1.25	<b>J</b>
01.5	<b>K</b>
1.75	<b>L</b>
002.	<b>N</b>
02.5	<b>O</b>
003.	<b>P</b>
03.5	<b>R</b>
004.	<b>S</b>
005.	<b>T</b>
007.	<b>W</b>
008.	<b>X</b>

### Part Numbering System

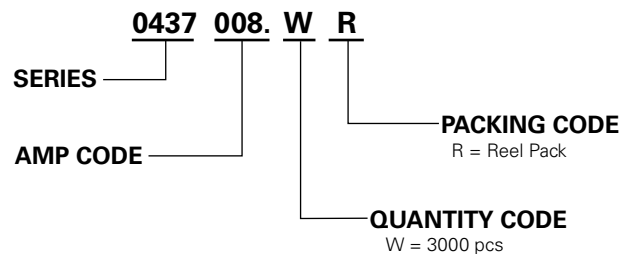

### Packaging

Packaging Option	Packaging Specification	Quantity	Quantity & Packaging Code
8mm Tape and Reel	EIA-481-1 (IEC 286, part 3)	3000	WR

